

# Project Group

## GNSS Training, Team No: 08

Team Members' Name	E-mail ID
Tek Bahadur Kshetri	iamtekson@gmail.com
Saurav KC	st120967@ait.asia
Arjun Rajlawat	noozrajlawat@gmail.com
Nyamdagva Ayush	nyamdagva.a@gmail.com

# • Presentation Content

## Zero Baseline Data

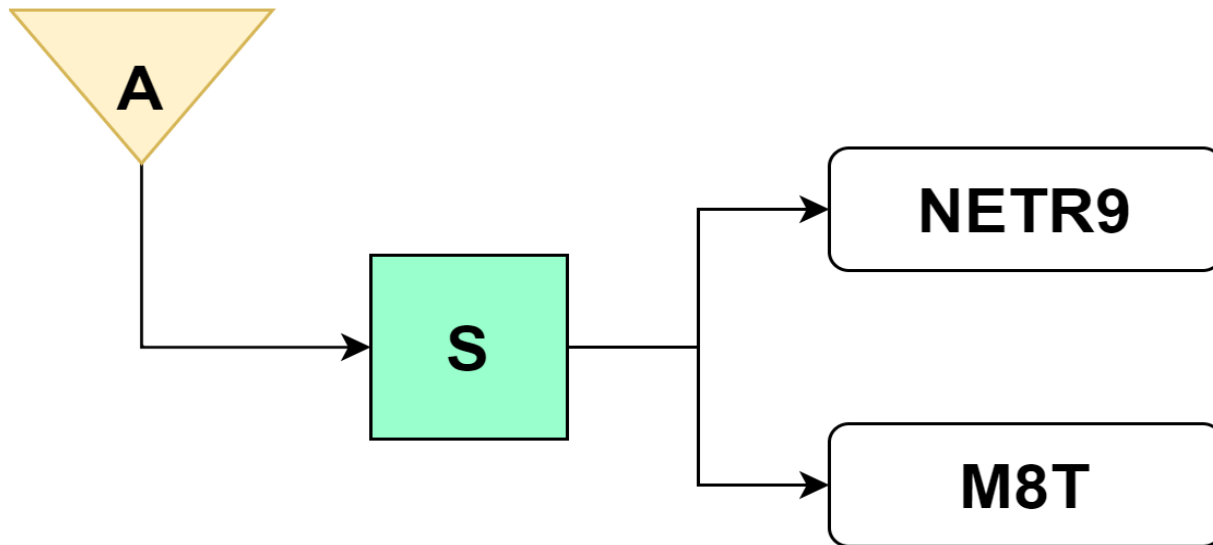

## Data Processing

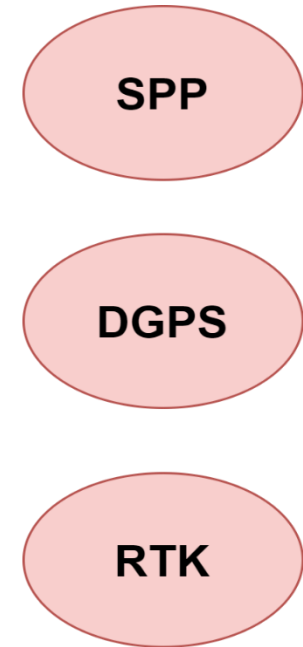

# SPP- Method

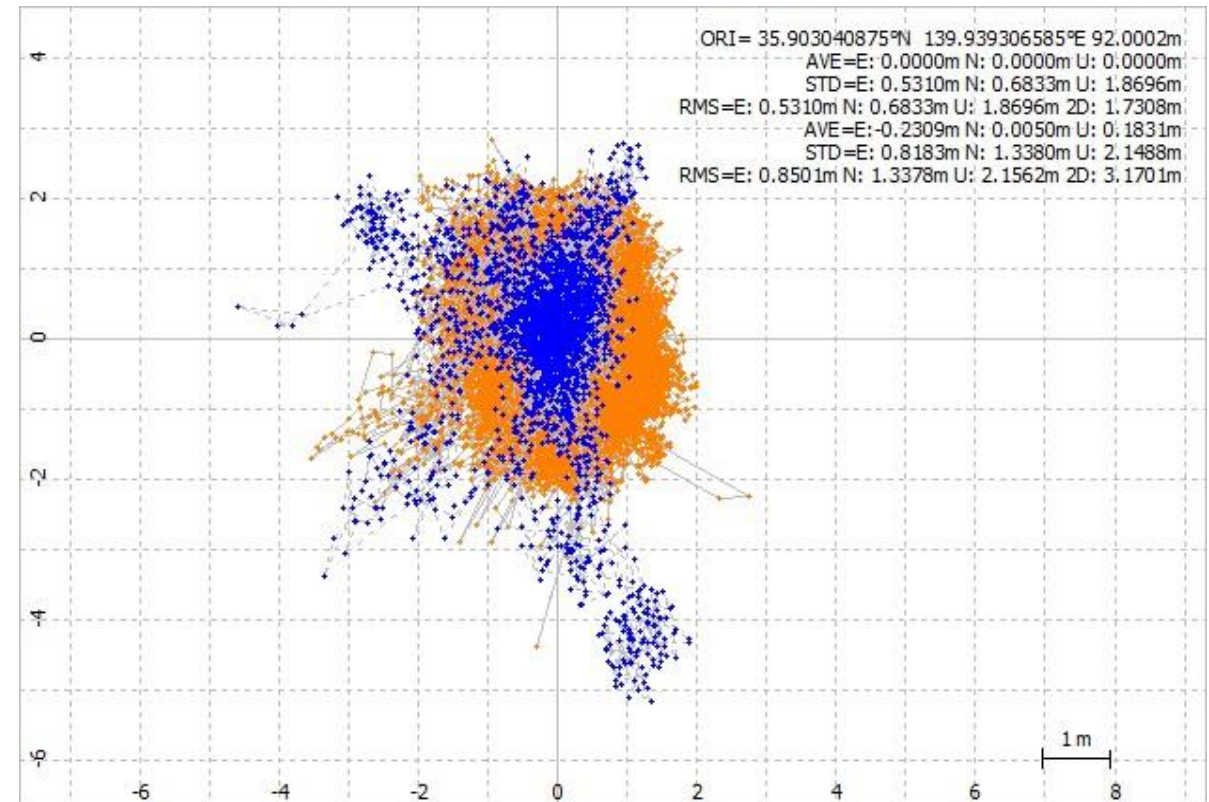
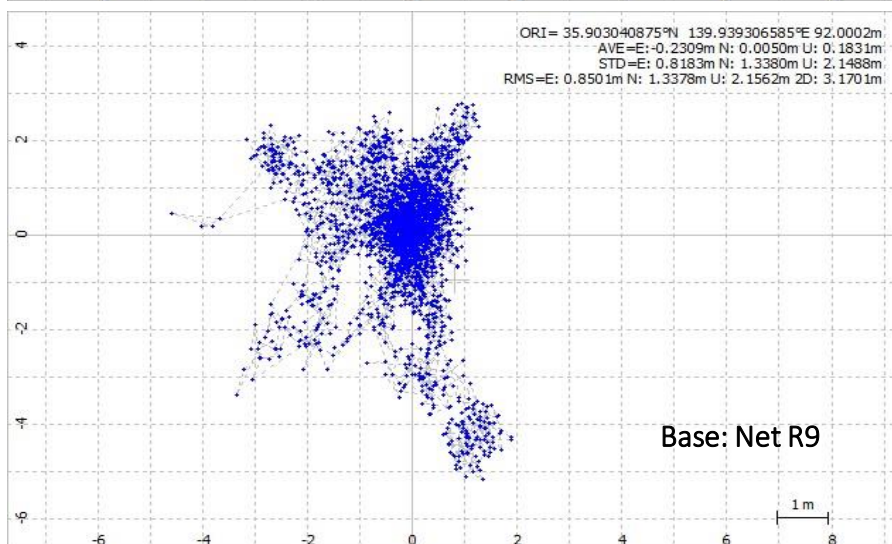
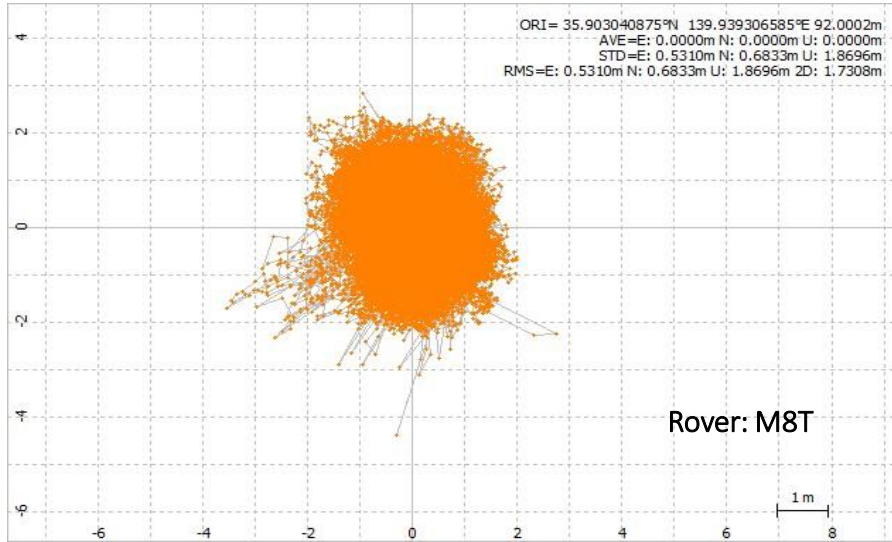

# DGPS- Method

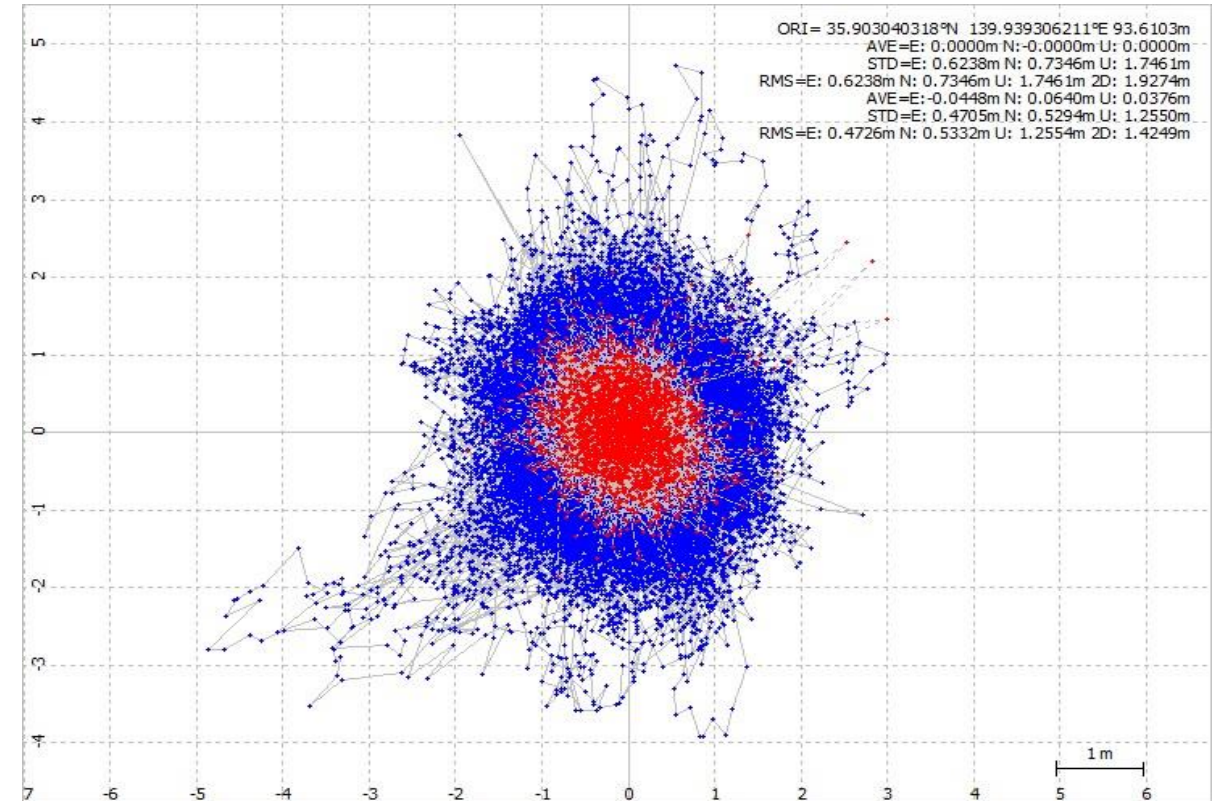
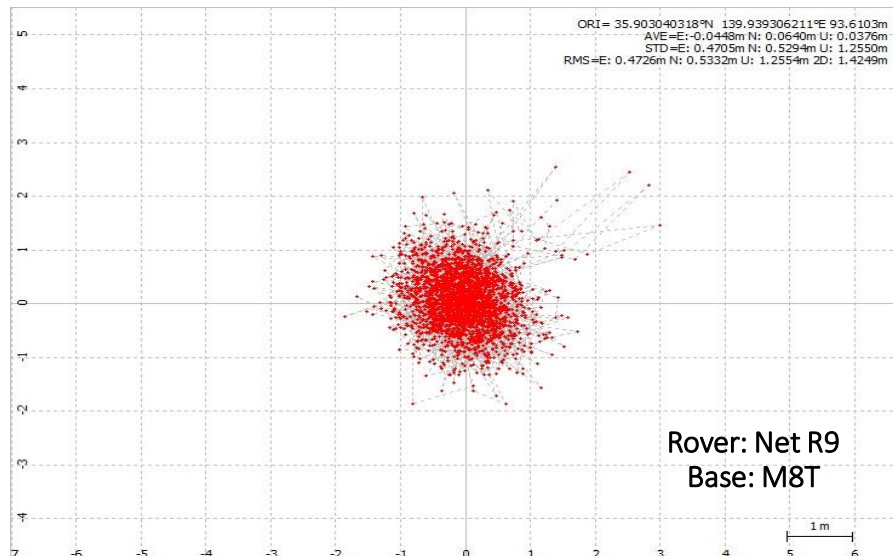
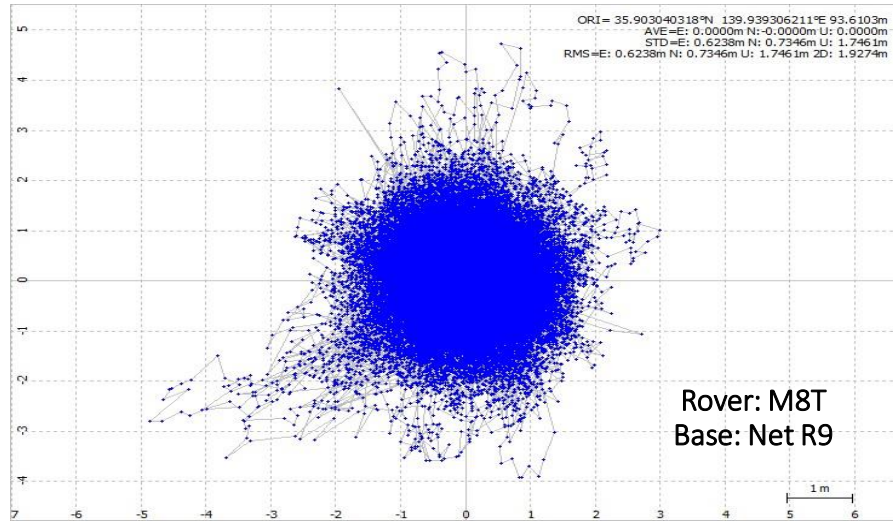

# RTK- Method

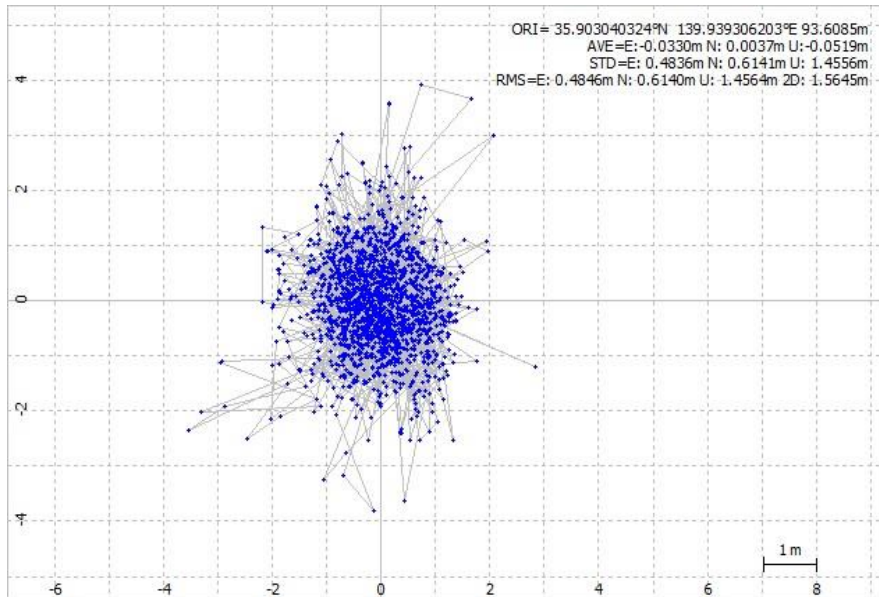

Rover: M8T  
Base: Net R9

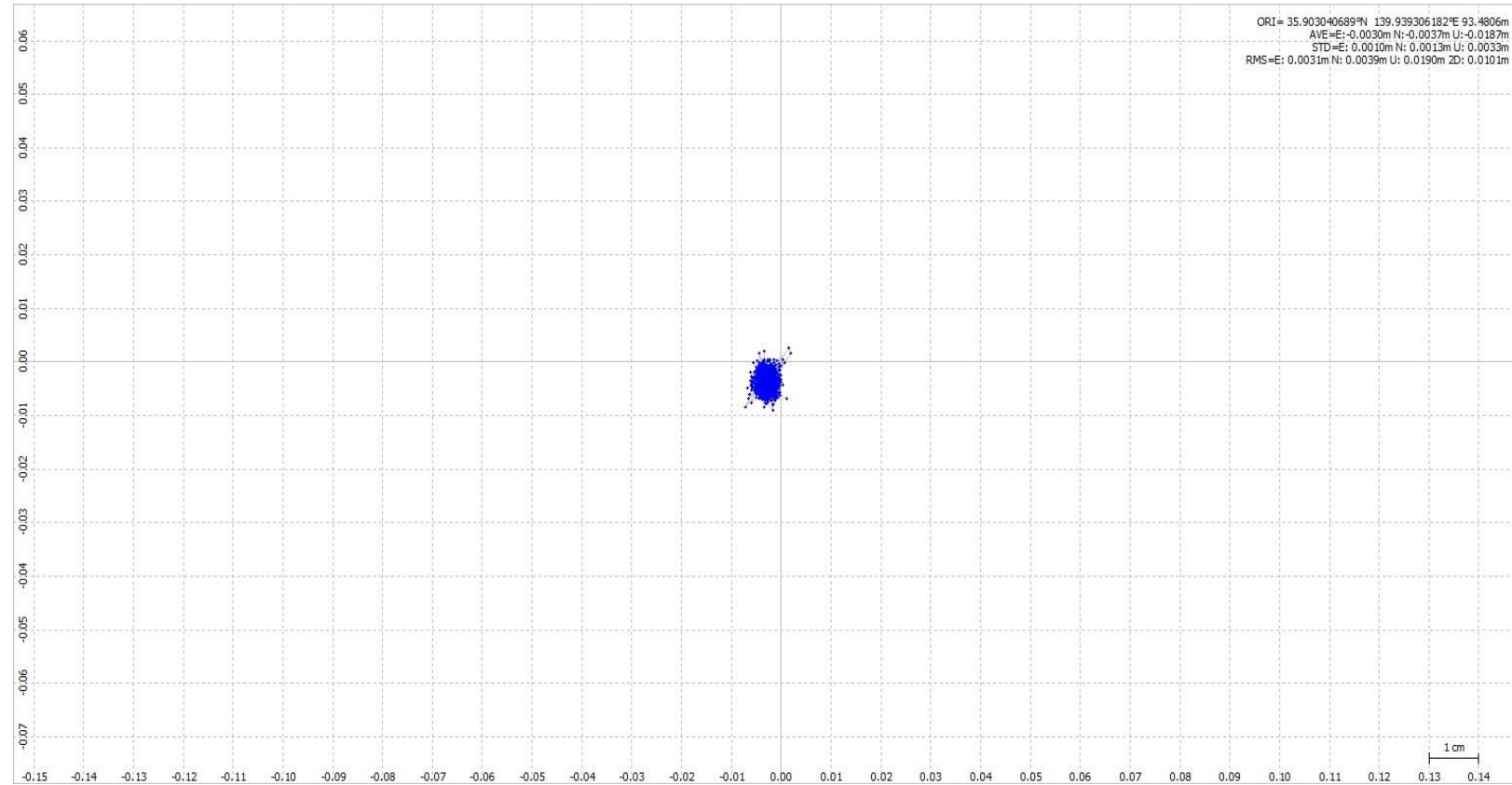

Rover: NetR9  
Base: M8T

# Error Analysis – M8T

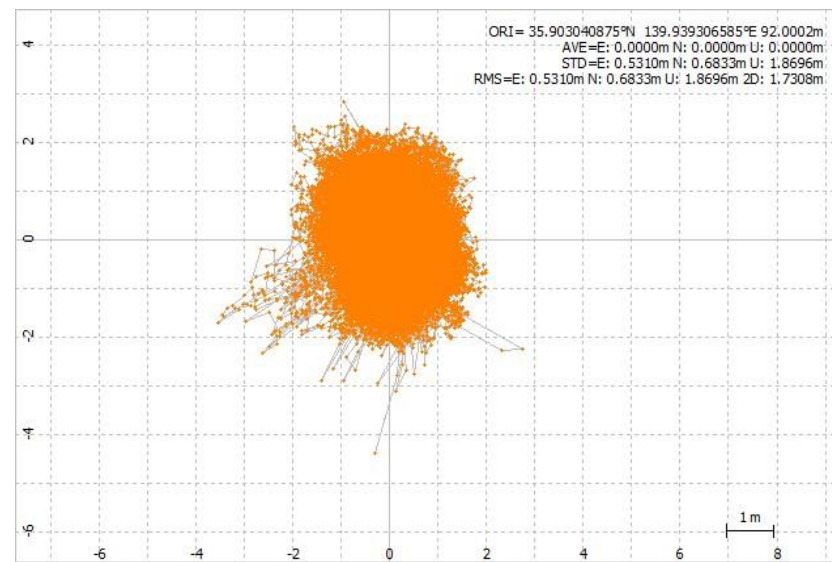

**SPP**

X	Y	Z
0.892	-0.802	-0.838

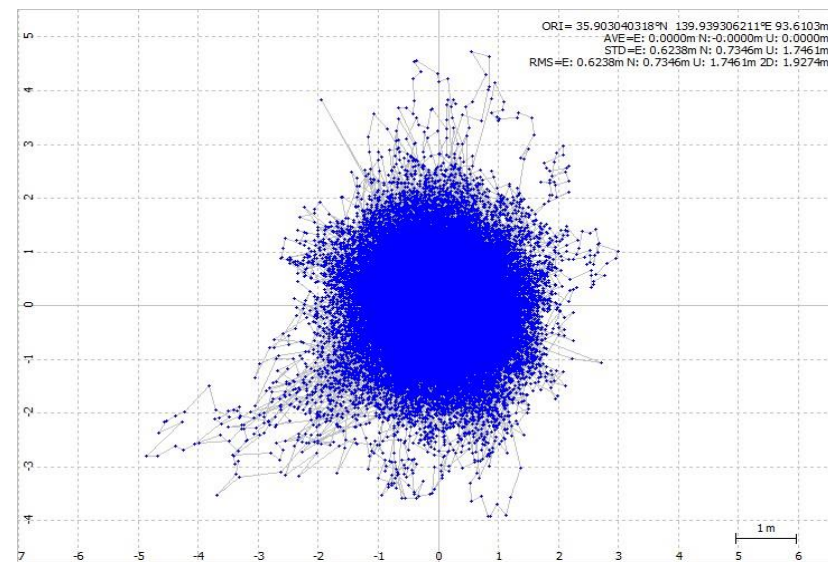

**DGPS**

X	Y	Z
-0.112	0.086	0.056

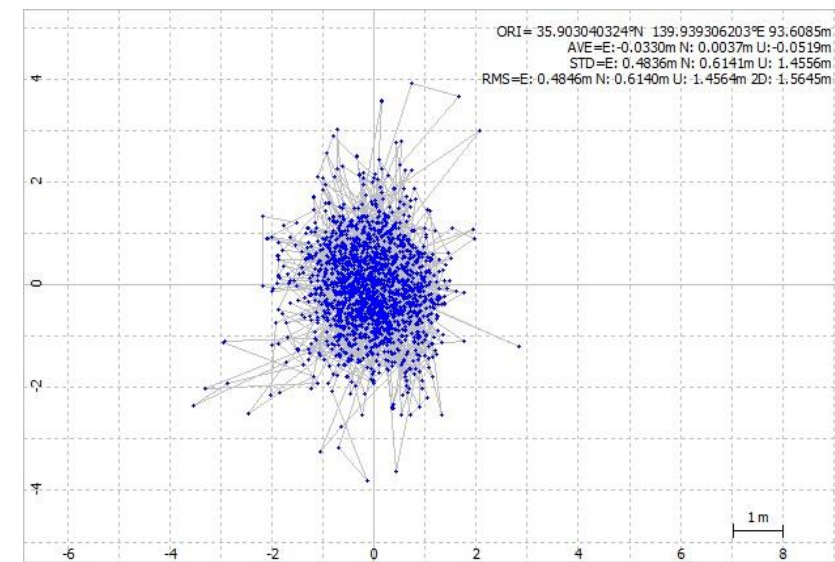

**RTK**

X	Y	Z
-0.110	0.086	0.056



# Thank You